

Pfaff 146



---

**PFAFF**<sup>®</sup> **146**



**Unterklassen-Ausstattung**

Subclass parts

Composition des sous-classes

Composición de las subclases

Unterklassen-Ausstattung<sup>1)</sup>

Subclass organization<sup>1)</sup>

Equipement des sous-classes<sup>1)</sup>

Dotación de las subclases<sup>1)</sup>

Unterklasse Subclass Sous-classe Subclase	Ausführung Model Version Tipo de máquina	Nadelabstand in mm Needle gauge in mm Ecartement des aiguilles en mm Distancia entre agujas en mm	Nadelstange [10.2] Needle bar Barre à aiguille Barra de aguja	Stoffschieber [4] [10.1] [10.2] Feed dog Griffe Transportador inferior	Stichplatte [4] [10.1] [10.2] Needle plate Plaque à aiguille Placa de aguja	Nähfuß [4] [10.2] Presser foot Pied presseur Pie prensateelas	Stoffschieberfuß [4] [10.1] [10.2] Vibrating presser Pied entraîneur Transportador superior
-6/01*	B; BN	2,4-26,0 28,0-36,0 38,0-50,0	91-710 749-93 91-710 750-93 91-710 750-93	91-040 433-04 91-040 433-04 91-047 275-93	91-040 434-04	91-040 429-04	91-040 430-93
-57/01*	B; BN	4,0-10,0 11,2-20,0	91-710 749-93	91-040 433-04	91-040 434-04	91-040 429-04	91-040 430-93
-58/01*	B; BN	4,0-10,0 11,2-20,0	91-710 749-93	91-040 433-04	91-040 434-04	91-040 429-04	91-040 430-93
-59/02*	B; BN	6,0-26,0	91-710 749-93	91-040 433-04	91-040 434-04	91-040 429-04	91-040 430-93
-59/02*	B; BN	28,0-36,0	91-710 750-93	91-040 433-04	91-040 434-04	91-040 429-04	91-040 430-93
-59/02	B; BN	38,0-50,0	91-710 750-93	91-047 275-93	91-040 434-04	91-040 429-04	91-040 430-93
-61/02*	B; BN	6,0-26,0 28,0-36,0 38,0-50,0	91-710 749-93 91-710 750-93 91-710 750-93	91-040 433-04 91-040 433-04 91-047 275-93	91-040 434-04	91-040 429-04	91-040 430-93
-68/12	B; BN	20,0-26,0 28,0-36,0 38,0-40,0	91-710 749-93 91-710 750-93 91-710 750-93	91-040 433-04 91-040 433-04 91-047 275-93	91-491 945-04	91-040 429-04	91-040 430-93
-69/02*	B; BN	6,0-26,0 28,0-36,0 38,0-50,0	91-710 749-93 91-710 750-93 91-710 750-93	91-040 433-04 91-040 433-04 91-047 275-93	91-040 434-04	91-040 429-04	91-040 430-93
-69/22*	B; BN	7,2-26,0 28,0	91-710 749-93 91-710 750-93	91-040 433-04	91-040 434-04	91-046 933-04	91-046 932-93
-71/02*	B; BN	6,0-26,0	91-710 749-93	91-040 433-04	91-040 434-04	91-040 429-04	91-040 430-93
-71/02*	B; BN	28,0-36,0	91-710 750-93	91-040 433-04	91-040 434-04	91-040 429-04	91-040 430-93
-71/02	B; BN	38,0-72,0	91-710 750-93	91-047 275-93	91-040 434-04	91-040 429-04	91-040 430-93
-71/21*	B; BN	6,0-26,0	91-010 749-93	91-040 433-04	91-040 434-04	91-040 429-04	91-040 430-93
-71/21*	B; BN	28,0-30,0	91-010 750-93	91-040 433-04	91-040 434-04	91-040 429-04	91-040 430-93
-72/02*	B; BN	6,0-26,0 28,0-36,0 38,0-50,0	91-710 749-93 91-710 750-93 91-710 750-93	91-040 433-04 91-040 433-04 91-047 275-93	91-040 434-04	91-040 429-04	91-040 430-93
-76/01*	B; BN	6,0-20,0	91-710 749-93	91-040 433-04	91-040 434-04	91-042 088-05	91-042 087-93 [3]
-82/02*	B; BN	6,0-26,0	91-010 749-93	91-040 433-04	91-040 434-04	91-040 429-04	91-040 430-93
-82/02*	B; BN	28,0-30,0	91-010 750-93	91-040 433-04	91-040 434-04	91-040 429-04	91-040 430-93
-87/02*	B; BN	6,0-26,0 28,0-30,0	91-010 749-93 91-010 750-93	91-040 433-04	91-040 434-04	91-040 429-04	91-040 430-93
-88/02*	B; BN	6,0-26,0	91-710 749-93	91-040 433-04	91-040 434-04	91-040 429-04	91-040 430-93
-88/02*	B; BN	28,0-36,0	91-710 750-93	91-040 433-04	91-040 434-04	91-040 429-04	91-040 430-93
-88/02*	B; BN	38,0-50,0	91-710 750-93	91-047 275-93	91-040 434-04	91-040 429-04	91-040 430-93
-89/02*	B; BN	6,0-26,0	91-710 749-93	91-040 433-04	91-040 434-04	91-040 429-04	91-040 430-93
-89/02*	B; BN	28,0-36,0	91-710 750-93	91-040 433-04	91-040 434-04	91-040 429-04	91-040 430-93
-89/02	B; BN	38,0-50,0	91-710 750-93	91-047 275-93	91-040 434-04	91-040 429-04	91-040 430-93

Unterklassen-Ausstattung<sup>1)</sup>

Subclass organization<sup>1)</sup>

Subclass Sous-classe Subclase	Ausführung Model Version Tipo de máquina	Apparat Appareil Aparato	Träger Bracket Support Soporte	Kopfplatte Face plate Plaque frontale Placa frontal	Bandrommel Tape reel Tambour-derouleux Tambor portacintas	Bandführung Tape guide Guide-ruban Guiacintas	Fingerschutz Finger guard Protecteur Salvadatos
1/01*	B; BN						91-055 203-91 ☐ = 2,4- 8, 91-055 200-91 ☐ = 9,2-32, 91-057 091-91 ☐ = 34,0-50,(
17/01*	B; BN	91-040 317-93 ☐ 91-042 068-24 ☐					**
18/01*	B; BN	91-040 316-93 ☐ 91-040 814-23 ☐					**
19/02*	B; BN	91-043 408-23 91-042 429-23	91-040 862-90 91-040 528-90	91-010 702-91	91-040 207-91 91-041 644-91	91-044 419-25	**
19/02*	B; BN	91-043 408-23 91-042 429-23	91-040 862-90 91-040 528-90	91-010 702-91	91-040 207-91 91-041 644-91	91-044 419-25	**
19/02	B; BN	91-043 408-23 91-042 429-23	91-040 862-90 91-040 528-90	91-010 702-91	91-040 207-91 91-041 644-91	91-044 419-25	**
1/02*	B; BN	91-043 408-23	91-040 862-90	91-010 702-91	91-040 207-91		**
8/12	B; BN	91-488 382-23	91-053 936-90		91-041 644-91	91-044 419-25	**
9/02*	B; BN	91-040 769-23 ☐	91-040 862-90	91-010 702-91	91-040 207-91		**
9/22*	B; BN	91-046 724-24	91-040 862-90	91-010 702-91	91-046 254-91		**
1/02*	B; BN	91-040 769-23 ☐ 91-044 734-23	91-040 862-90 91-040 528-90	91-010 702-91	91-040 207-91 91-041 644-91	91-044 419-25	**
1/02*	B; BN	91-040 769-23 ☐ 91-044 734-23	91-040 862-90 91-040 528-90	91-010 702-91	91-040 207-91 91-041 644-91	91-044 419-25	**
1/02	B; BN	91-040 769-23 ☐ 91-044 734-23	91-040 862-90 91-040 528-90	91-010 702-91	91-040 207-91 91-041 644-91	91-044 419-25	**
1/21*	B; BN	91-040 769-23 ☐ 91-026 588-23 ☐	91-040 862-90	91-010 702-91	91-040 207-91 91-041 644-91	91-044 419-25	**
1/21*	B; BN	91-040 769-23 ☐ 91-026 588-23 ☐	91-040 862-90	91-010 702-91	91-040 207-91 91-041 644-91	91-044 419-25	**
2/02*	B; BN	91-042 429-23	91-040 528-90		91-041 644-91	91-044 419-25	**
3/01*	B; BN	91-042 086-24					**
2/02*	B; BN	91-043 408-23 91-041 906-23	91-040 862-90 91-040 528-90	91-010 702-91	91-040 207-91		**
2/02*	B; BN	91-043 408-23 91-041 906-23	91-040 862-90 91-040 528-90	91-010 702-91	91-040 207-91		**
7/02*	B; BN	91-040 145-23 ☐	91-040 528-90				**
1/02*	B; BN	91-043 408-23 91-044 734-23	91-040 862-90 91-040 528-90	91-010 702-91	91-040 207-91 91-041 644-91	91-044 419-25	**
1/02*	B; BN	91-043 408-23 91-044 734-23	91-040 862-90 91-040 528-90	91-010 702-91	91-040 207-91 91-041 644-91	91-044 419-25	**
1/02*	B; BN	91-043 408-23 91-044 734-23	91-040 862-90 91-040 528-90	91-010 702-91	91-040 207-91 91-041 644-91	91-044 419-25	**
1/02*	B; BN	91-040 769-23 ☐ 91-044 734-23	91-040 862-90 91-040 528-90	91-010 702-91	91-040 207-91 91-041 644-91	91-044 419-25	**
1/02*	B; BN	91-040 769-23 ☐ 91-044 734-23	91-040 862-90 91-040 528-90	91-010 702-91	91-040 207-91 91-041 644-91	91-044 419-25	**
1/02	B; BN	91-040 769-23 ☐ 91-044 734-23	91-040 862-90 91-040 528-90	91-010 702-91	91-040 207-91 91-041 644-91	91-044 419-25	**



Unterklassen-Ausstattung )  
 Equipement des sous-classes<sup>1)</sup>

Subclass organization /  
 Dotación de las subclases<sup>1)</sup>

Unterklasse Subclass Sous-classe Subclase	Ausführung Model Version Tipo de máquina	Nadelabstand in mm Needle gauge in mm Ecartement des aiguilles en mm Distancia entre agujas en mm	Nadelstange Needle bar Barre à aiguille Barra de aguja	Stoffschieber Feed dog Gaffe Transportador inferior	Stichplatte Needle plate Plaque à aiguille Placa de aguja	Nähfuß Presser foot Pied presseur Pie prensateelas	Stoffschieber Vibrating presser Pied entraîneur Transportador superior
-91/02*	B; BN	6,0-26,0 28,0-36,0 38,0-40,0	91-710 749-93 91-710 750-93 91-710 750-93	91-040 433-04 91-040 433-04 91-047 275-93	91-040 434-04	91-040 429-04	91-040 430-93
-94/02*	B; BN	2,4-26,0 28,0-30,0	91-710 749-93 91-710 750-93	91-040 433-04	91-040 434-04	91-042 708-04	91-049 023-93
-99/02*	B; BN	6,0-26,0 28,0-30,0	91-710 749-93 91-710 750-93	91-040 433-04	91-040 434-04	91-040 429-04	91-040 430-93
-116/02*	B; BN	2,4-20,0	91-710 749-93	91-040 433-04	91-040 434-04	91-040 429-04	91-040 430-93
-120/01*	B; BN	2,4-20,0	91-710 749-93	91-040 433-04	91-040 434-04	91-042 377-05 [3]	91-042 376-93 [3]
-167/02*	B; BN	2,4-26,0 28,0-30,0	91-710 749-93 91-710 750-93	91-040 433-04	91-040 434-04	91-040 429-04	91-040 430-04
-167/12*	B; BN	2,4-26,0 28,0-30,0	91-710 749-93 91-710 750-93	91-040 433-04	91-040 434-04	91-040 429-04	91-040 430-04
-176/01*	B; BN	2,4-20,0	91-710 749-93	91-040 433-04	91-040 434-04	91-044 449-04 [3]	91-044 448-93 [3]
-184/02*	B; BN	7,2-26,0	91-710 749-93	91-040 433-04	91-040 434-04	91-049 503-03 [3]	91-049 144-93 [3]
-189/12	B; BN	3,2-26,0 28,0-30,0	91-710 749-93 91-710 750-93	91-042 347-04	91-042 348-04	91-042 708-04	91-049 023-93
-230/01*	B; BN	8,0-26,0 28,0-30,0	91-710 749-93 91-710 750-93	91-040 433-04	91-040 434-04	91-049 503-03 [3]	91-049 144-93 [3]
-230/02	B; BN	8,0-26,0	91-710 749-93	91-490 842-04 [3]	91-490 841-04 [3]	91-486 629-04 [3]	91-486 628-93 [3]
-230/03	B; BN	28,0-30,0	91-710 750-93	91-490 842-04 [3]	91-490 841-04 [3]	91-486 629-04 [3]	91-486 628-93 [3]
-230/21*	B; BN	8,0-26,0 28,0-30,0	91-710 749-93 91-710 750-93	91-040 433-04	91-040 434-04	91-049 503-03 [3]	91-049 144-93 [3]
-230/22	B; BN	8,0-26,0 28,0-30,0	91-710 749-93 91-710 750-93	91-490 842-04 [3]	91-490 841-04 [3]	91-486 629-04 [3]	91-486 628-93 [3]
-232/11*	B; BN	2,4-26,0 28,0-30,0	91-710 749-93 91-710 750-93	91-040 433-04	91-040 434-04	91-040 429-04	91-040 430-93
-237/01*	B; BN	8,0-26,0 28,0-30,0	91-710 749-93 91-710 750-93	91-040 433-04	91-040 434-04	91-049 503-03 [3]	91-049 144-93 [3]
-237/06*	B	8,0-20,0	91-710 749-93	91-059 016-04	91-040 434-04	91-049 503-03 [3]	91-049 144-93 [3]
-237/10	B	8,0-20,0	91-710 749-93	91-047 389-04 [3]	91-058 093-04 [3]	91-049 503-03 [3]	91-049 144-93 [3]
-237/10 -900/11; /51	B	8,0-20,0	91-710 749-93	91-047 389-04 [3]	91-058 170-04 [3]	91-049 503-03 [3]	91-049 144-93 [3]
-237/10 -900/16; /56	B	8,0-20,0	91-710 749-93	91-047 389-04 [3]	91-058 840-04 [3]	91-049 503-03 [3]	91-049 144-93 [3]
-255/01*	B; BN	8,0-26,0 28,0-30,0	91-710 749-93 91-710 750-93	91-040 433-04	91-040 434-04	91-049 503-03 [3]	91-049 144-93 [3]

\* Unterklasse kann mit Fadendurchzieh- und -abschneideeinrichtung -900/... in den Nadelabständen 2,4; 3,2; 4,0; 4,8; 5,2; 6,0; 6,4; 7,2; 8,0; 9,2; 10,0; 11,2; 12,0; 13,2; 14,0; 15,2; 16,0; 18,0; 20,0; 22,0; 24,0; 25,2; 26,0; 28,0 und 30,0 mm geliefert werden, jedoch nur unter Berücksichtigung des in der Tabelle angegebenen Nadelabstandsbereichs.  
 Bei Maschinen mit -900/11; /51 ändert sich die Bestellnummer der Stichplatte von 91-040 434-04 in 91-058 424-04 und bei -900/16; /56 in 91-058 945-04.

\* This subclass can be supplied with thread puller/trimmer -900/... in the following needle gauges: 2,4, 3,2, 4,0, 4,8, 5,2, 6,0, 6,4, 7,2, 8,0, 9,2, 10,0, 11,2, 12,0, 13,2, 14,0, 15,2, 16,0, 18,0, 20,0, 22,0, 24,0, 25,2, 26,0, 28,0 and 30,0 mm, provided they fall within the needle gauge range listed in the table.  
 For machines with -900/11 and /51 the ordering number of the needle plate is changed from 91-040 434-04 to 91-058 424-04, and for subcl. -900/16 and /56 to 91-058 945-04.

\*\* For ordering number see subcl. -6/01

\*\* Bestellnummer siehe Unterklasse -6/01

[1] = Ausführung angeben  
 = Indicate model  
 = Préciser la version  
 = Indiquez el tipo de máquina

[3] = Nahmuster einsenden  
 = Submit sewing sample  
 = Joindre échantillons de couture  
 = Envíese muestra de costura

[6] = Nadelabstand  
 = Needle gauge  
 = Ecartement des aiguilles  
 = Distancia entre agujas

**Equipement des sous-classes<sup>1)</sup>**  
**Unterklassen-Ausstattung<sup>1)</sup>**

**Dotación de las subclases<sup>1)</sup>**  
**Subclass organization<sup>1)</sup>**

Soins-classe Subclasse	Ausführung Model Version Tipo de máquina	Apparat [3] Attachement Appareil Aparato	Träger Bracket Support Soporte	Kopfplatte Face plate Plaque frontale Placa frontal	Halterwinkel Bracket Equerre de retenue Soporte angular	Bandtrommel Tape reel Tambour rétroviseur Tambor portatintas	Bandführung Tape guide Guide-bande Guías cintas	Bandrolle Tape disc Plaque circulaire Plato portatintas
1/02*	B; BN	91-041 620-23	91-040 528-90					
4/02*	B; BN	91-046 014-23	91-040 528-90					
9/02*	B; BN	91-042 848-23	91-040 528-90			91-041 644-91	91-044 419-25	
16/02*	B; BN	91-042 350-24	91-040 528-90			91-041 644-91	91-044 419-25	
20/01*	B; BN	91-042 404-24						
37/02*	B; BN	91-053 637-25	91-040 528-90			91-041 644-91		
37/12*	B; BN	91-046 706-24	91-040 528-90			91-041 644-91	91-044 419-25	
76/01*	B; BN	91-044 447-24						91-043 943-91
34/02*	B; BN	91-490 198-24	91-040 528-90					
39/12	B; BN	91-053 278-24	91-040 528-90			91-042 742-91	91-044 419-25	
30/01*	B; BN	91-053 534-93						
30/02	B; BN	91-489 491-23 91-490 355-23	91-040 862-90	91-010 702-91				
30/02	B; BN	91-489 491-23 91-490 355-23	91-040 862-90	91-010 702-91				
30/21*	B; BN	91-053 537-24						
30/22	B; BN	91-489 491-23 91-490 355-23	91-040 862-90	91-010 702-91				
32/11*	B; BN	91-050 003-23				91-041 644-91	91-044 419-25	
37/01*	B; BN	91-053 531-24						
37/06*	B	91-056 026-93 91-056 033-93		91-108 604-91	91-050 924-15			
37/10	B	91-056 040-93		91-108 604-91				
37/10 30/11; /51	B	91-056 040-93		91-108 604-91				
37/10 30/16; /56	B	91-056 040-93		91-108 604-91				
55/01*	B; BN	91-056 413-93 91-056 429-13		91-108 604-91	91-050 924-15	91-042 742-91		

\* En coupe-fil -900/... la sous-classe ne pourra être livrée que dans les écartements des aiguilles de 2,4; 3,2; 4,0; 4,8; 5,2; 6,0; 6,4; 7,2; 8,0; 9,2; 10,0; 11,2; 12,0; 13,2; 14,0; 15,2; 16,0; 18,0; 20,0; 22,0; 24,0; 25,2; 26,0; 28,0 et 30,0 mm, en tenant compte cependant des limitations des écartements, indiquées dans le tableau.  
 Dans le cas de machines avec -900/11 ou /51, le n° de commande de la plaque à aiguille passe de 91-040 434-04 à 91-058 424-04 et avec -900/16 ou /56 à 91-058 945-04.

\*\* N° de commande, voir ss-cl. -6/01

\* La subclasse se puede suministrar con cortahilos automático -900/... las distancias entre agujas siguientes: 2,4; 3,2; 4,0; 4,8; 5,2; 6,0; 6,4; 7,2; 8,0; 9,2; 10,0; 11,2; 12,0; 13,2; 14,0; 15,2; 16,0; 18,0; 20,0; 22,0; 24,0; 25,2; 26,0; 28,0 y 30,0 mm, pero siempre teniendo en cuenta las limitaciones de las distancias indicadas en la tabla.  
 En máquinas con -900/11 y /51 el N° de pedido de la placa de aguja 91-040 434-04 se sustituye por el N° 91-058 424-04, y con -900/16 /56 por el N° 91-058 945-04.

\*\* Para el N° de pedido, véase la subclase -6/01

[10/1] = je nach Nadelabstand ändert sich die Form (z. B. beim Stoffschieber die Anzahl der Zahnreihen)  
 = Certain design features change according to the needle gauge (e. g. the number of tooth rows on the feed dog)  
 = La forme est fonction de l'écartement des aiguilles (par ex. le nombre des rangées de dents de la griffe).  
 = La forma varía de acuerdo con la distancia entre agujas

[10/2] = Nadelabstand bei Bestellung angeben  
 = State needle gauge on order  
 = Indiquer écartement des aiguilles à la commande  
 = Indicar a la ordenar la distancia entre agujas

# Equipement des sous-classes<sup>1)</sup>

# Dotación de las subclases<sup>1)</sup>

Unterklasse Subclasse Sous-classe Subclase	Ausführung Model Version Tipo de máquina	Anschlag Stop Butée Tope	Fadenabschneider Thread trimmer Coupe-fils Contahilos	Lüfthebel Lifting lever Lever releveur Palanca alzaprensacintas	Bohren Sud Bouhon Perno	Seilzug Pull cable Transmission par câble Cable de mando	Fingerschutz Finger guard Protecte-digits Salvadedos
-91/02*	B; BN						**
-94/02*	B; BN						**
-99/02*	B; BN						**
-116/02*	B; BN						**
-120/01*	B; BN						**
-167/02*	B; BN						**
-167/12*	B; BN						**
-176/01*	B; BN						**
-184/02*	B; BN						**
-189/12	B; BN						**
-230/01*	B; BN						**
-230/02	B; BN						**
-230/02	B; BN						**
-230/21*	B; BN						**
-230/22	B; BN						**
-232/11*	B; BN						**
-237/01*	B; BN						**
-237/06*	B	91-056 031-15	99-053-768-91	91-108-589-41 91-010 796-15	91-108 594-05	91-108 595-91	**
-237/10	B		99-053 768-91	91-108 589-41 91-010 796-15	91-108 594-05	91-108 595-91	**
-237/10 -900/11; /51	B	*	99-053 768-91	91-108 589-41 91-010 796-15	91-108 594-05	91-108 595-91	**
-237/10 -900/16; /56	B		99-053 768-91	91-108 589-41 91-010 796-15	91-108 594-05	91-108 595-91	**
-255/01*	B; BN			91-108 589-41	91-108 594-05	91-108 595-91	**

1) Die Liste enthält nur Nähwerkzeuge und Apparate. Beim Umbau in eine andere Unterklasse oder Ausführung sind auch noch Maschinenteile erforderlich. Geben Sie also bei Bestellungen die genaue Bezeichnung der vorhandenen und der gewünschten Ausführung bekannt.

1) This list contains sewing parts and attachments only. When converting to another subclass or version, machine parts are also necessary. When ordering please therefore indicate exactly the existing version and the one required.

1) Cette liste ne contient que les organes de couture et les guides. En cas de transformation en une sous-classe ou variante différente, il faut utiliser aussi certaines pièces de machine supplémentaires. En cas de commande, prière de toujours indiquer par conséquent les variantes disponibles et souhaitées.

1) Esta lista sólo contiene elementos de costura y aparatos. Siempre que haya que transformar la máquina en otro tipo o subclase, se necesitarán también piezas de máquina, por lo que deberá indicarse en los pedidos el tipo exacto de que se dispone y el deseado.

91-710 749-93 [10/2]

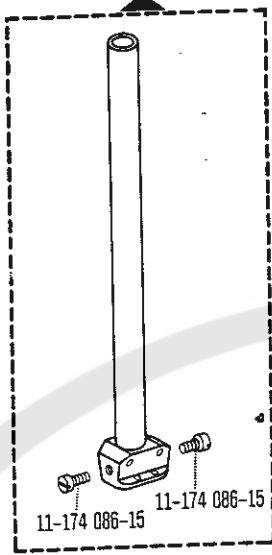

91-710 750-93 [10/2]

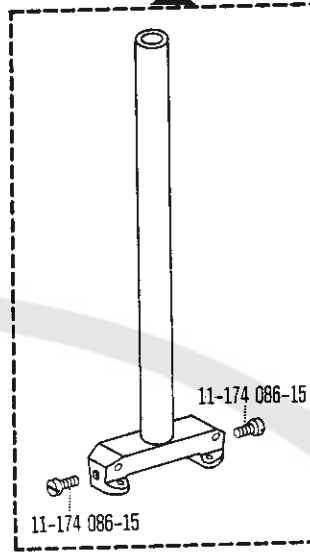

91-040 433-04 [4] [10/1] [10/2]



10 = 2,4-3,2 mm

91-040 433-04 [4] [10/2] [10/1]



10 = 4,8 mm >

91-042 347-04 [4] [10/1] [10/2]

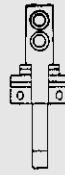

91-047 275-93 [4] [10/2] [10/1]

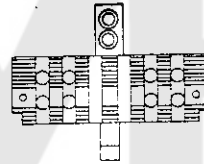

91-047 389-04 [4] [5] [10/1] [10/2]



91-059 016-04 [4] [10/1] [10/2]



91-490 842-04 [4] [5] [10/1] [10/2]



91-040 434-04 [4] [10/1] [10/2]



10 = 2,4-3,2 mm

91-040 434-04 [4] [10/1] [10/2]



10 = 4,8 mm >

91-040 434-04 [4] [10/1] [10/2] [10] = 38 - 50,0 mm

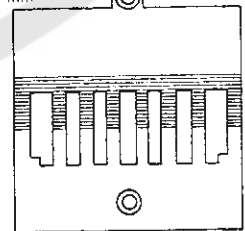

91-042 348-04 [4] [10/2] [10/1]

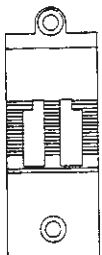

91-058 093-04 [4] [5] [10/1] [10/2]

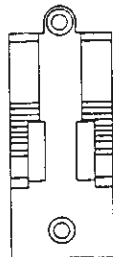

91-058 170-04 [4] [5] [10/1] [10/2]

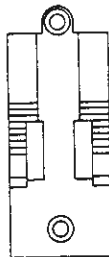

91-058 424-04 [4] [10/1] [10/2]

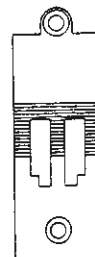

















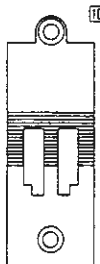



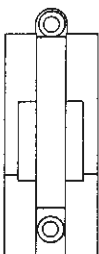











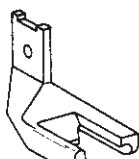











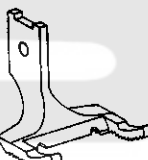







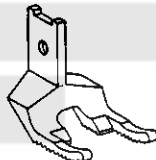













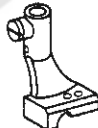

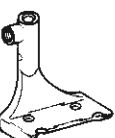



91-058 840-04 [4] [5] [10/1] [10/2]





Unterklassen-Übersicht / Table of subclasses / Table des sous-classes / Tabla de subclasses

<p>91-058 945-04   </p> <p> = 2,4-3,2 mm</p> 	<p>91-058 945-04   </p> <p> = 4,8 mm &gt;</p> 	<p>91-490 841-04  </p> <p> </p> 	<p>91-491 945-04   </p> 
<p>91-040 429-04  </p> 	<p>91-042 088-05 </p> 	<p>91-042 377-05  </p> <p></p> 	<p>91-042 708-04   </p> 
<p>91-044 449-04   </p> 	<p>91-046 933-04   </p> 	<p>91-049 503-03  </p> <p></p> 	<p>91-486 629-04  </p> <p></p> 
<p>91-040 430-93  </p> 	<p>91-042 087-93   </p> 	<p>91-042 376-93  </p> <p></p> 	<p>91-044 448-93   </p> 
<p>91-046 932-93  </p> 	<p>91-049 023-93   </p> 	<p>91-049 144-03  </p> <p></p> 	<p>91-486 628-93  </p> <p></p> 

91-026 588-23 [3] [10/2]

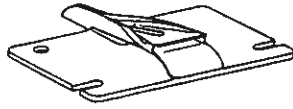

91-040 145-23 [5] [10/2]

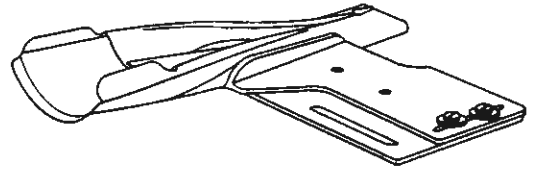

91-040 316-93 [5] [10/2]

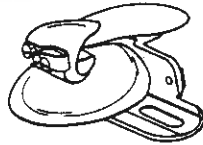

91-700 799-15

[10/2] [3] 91-040 317-93

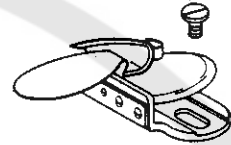

91-040 769-23 [3] [10/2]

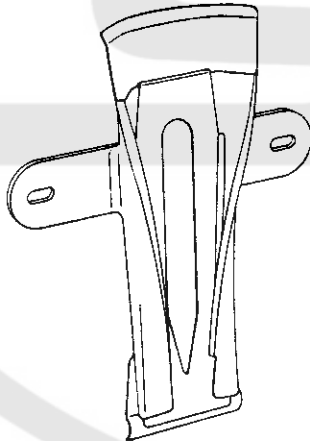

91-040 814-23 [3] [10/2]



91-041 620-23 [3]

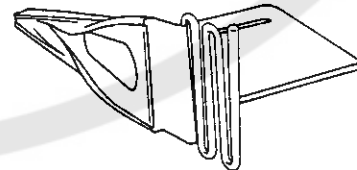

91-700 824-25



91-040 624-25

91-041 906-23 [3]

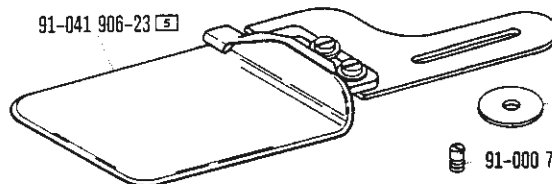

91-028 036-25



91-000 775-15

91-042 068-93 [4] [5] [10] [2]

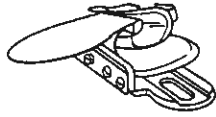

91-042 086-24 [5]

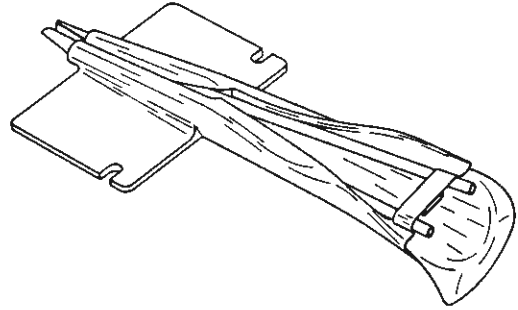

91-042 350-24 [5]

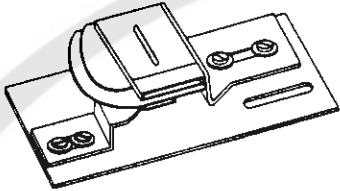

91-042 404-24 [3]

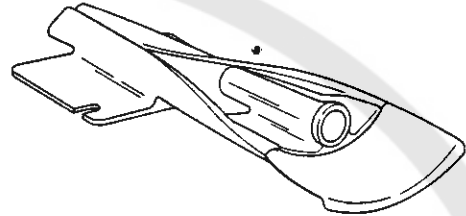

91-042 429-23 [5]

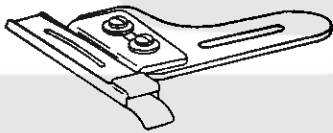

91-042 848-23 [5]

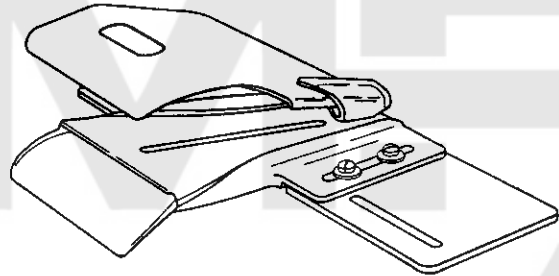

91-043 408-23 [5]

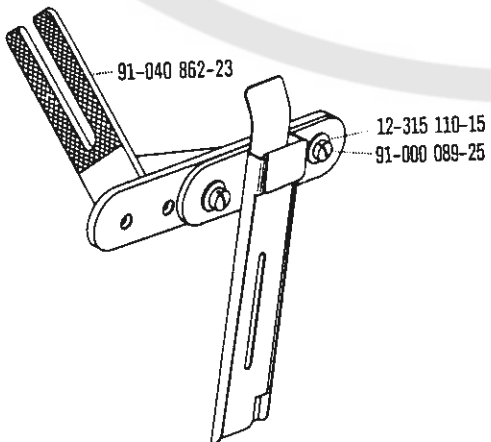

91-044 447-24 [5]

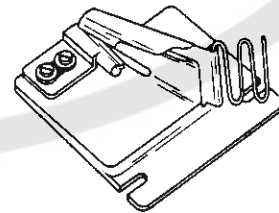

91-044 734-23 [5]

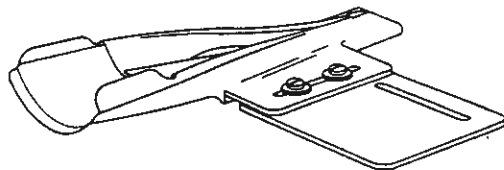

91-046 014-23 

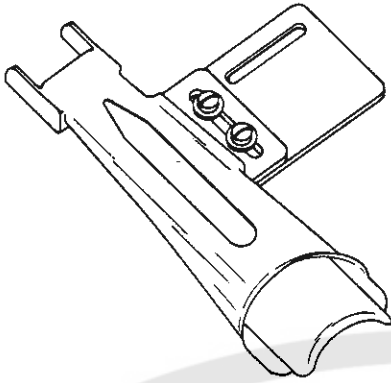

91-046 706-24 

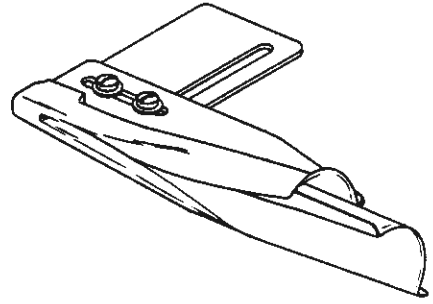

91-046 724-24 

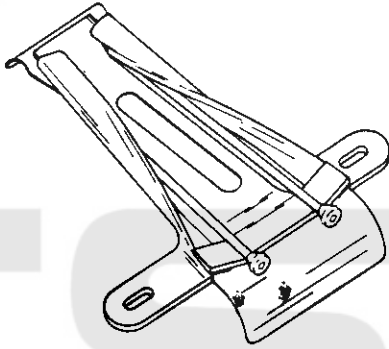

91-050 003-23 

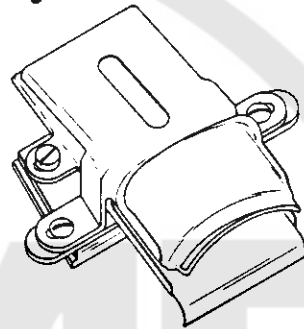

91-053 278-24 

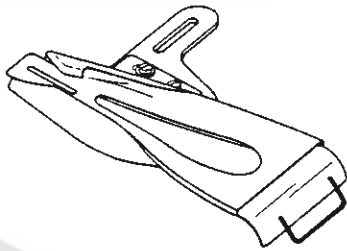

91-053 531-24 

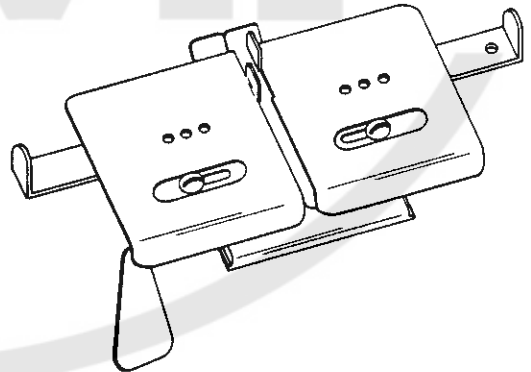

91-053 534-93 

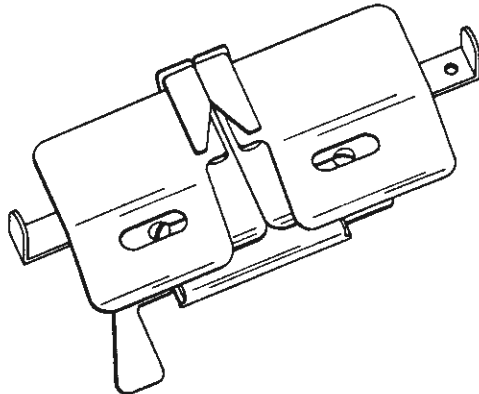

91-053 537-24 

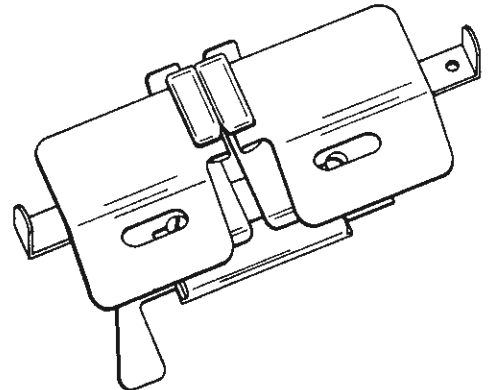

91-053 637-25 

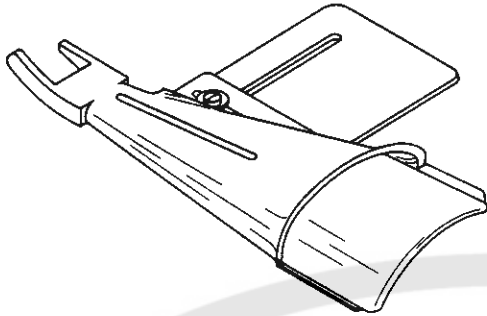

91-056 026-93 

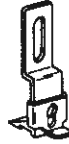

91-056 033-93 

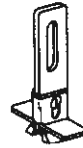

91-056 040-93 

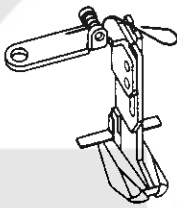

91-056 413-93 

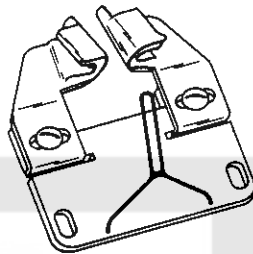

91-056 429-13 

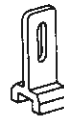

91-490 355-23 

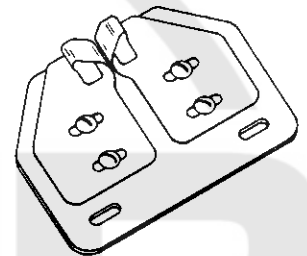

91-488 382-23 

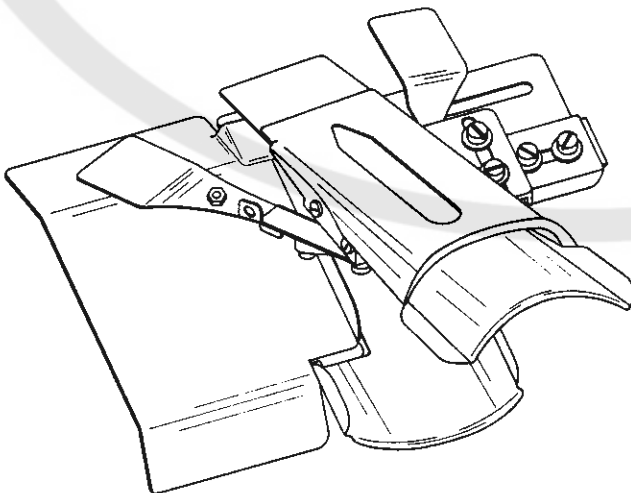

91-489 491-23 

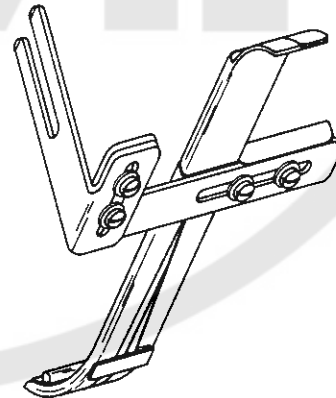

91-490 198-24 

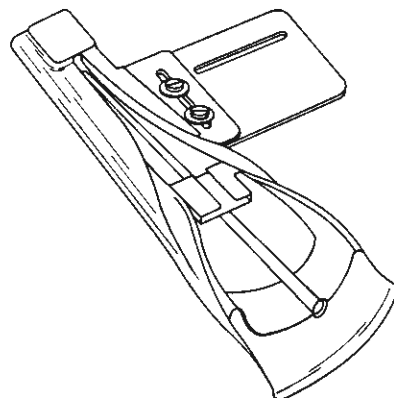

91-040 528-90

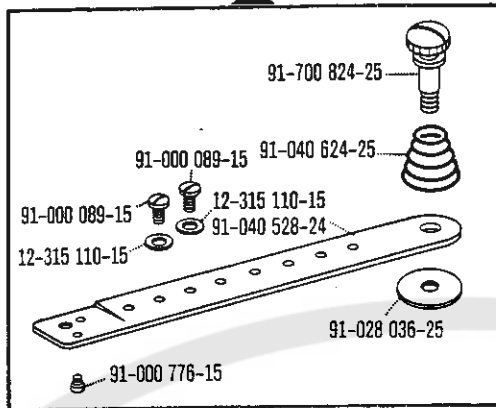

91-040 862-90

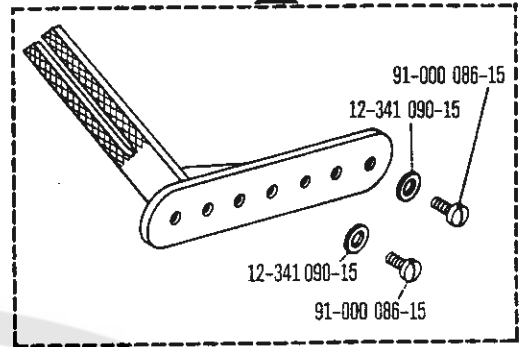

91-053 936-90

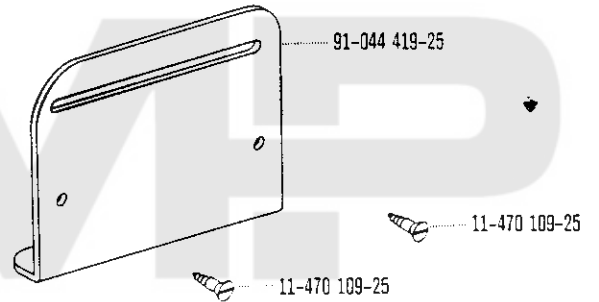
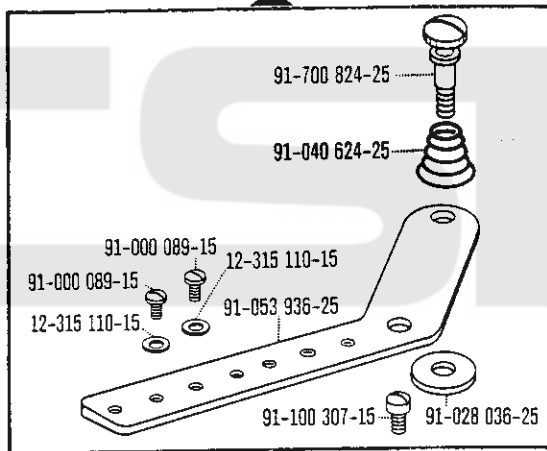

91-040 207-91

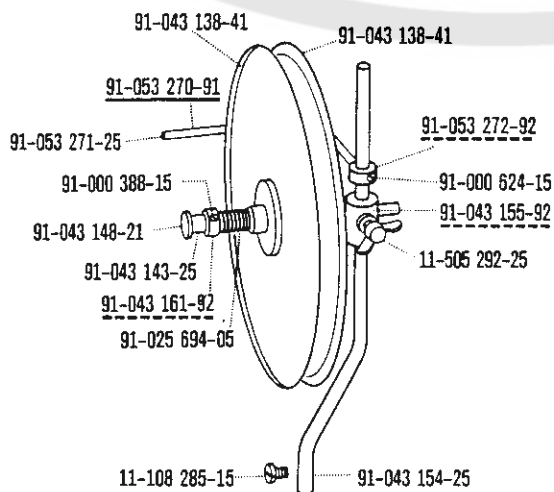

91-041 644-91

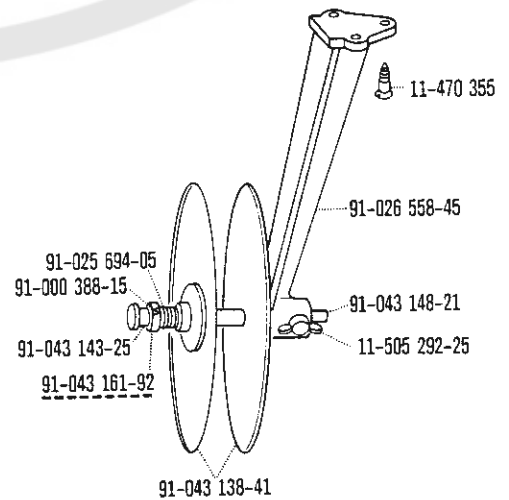

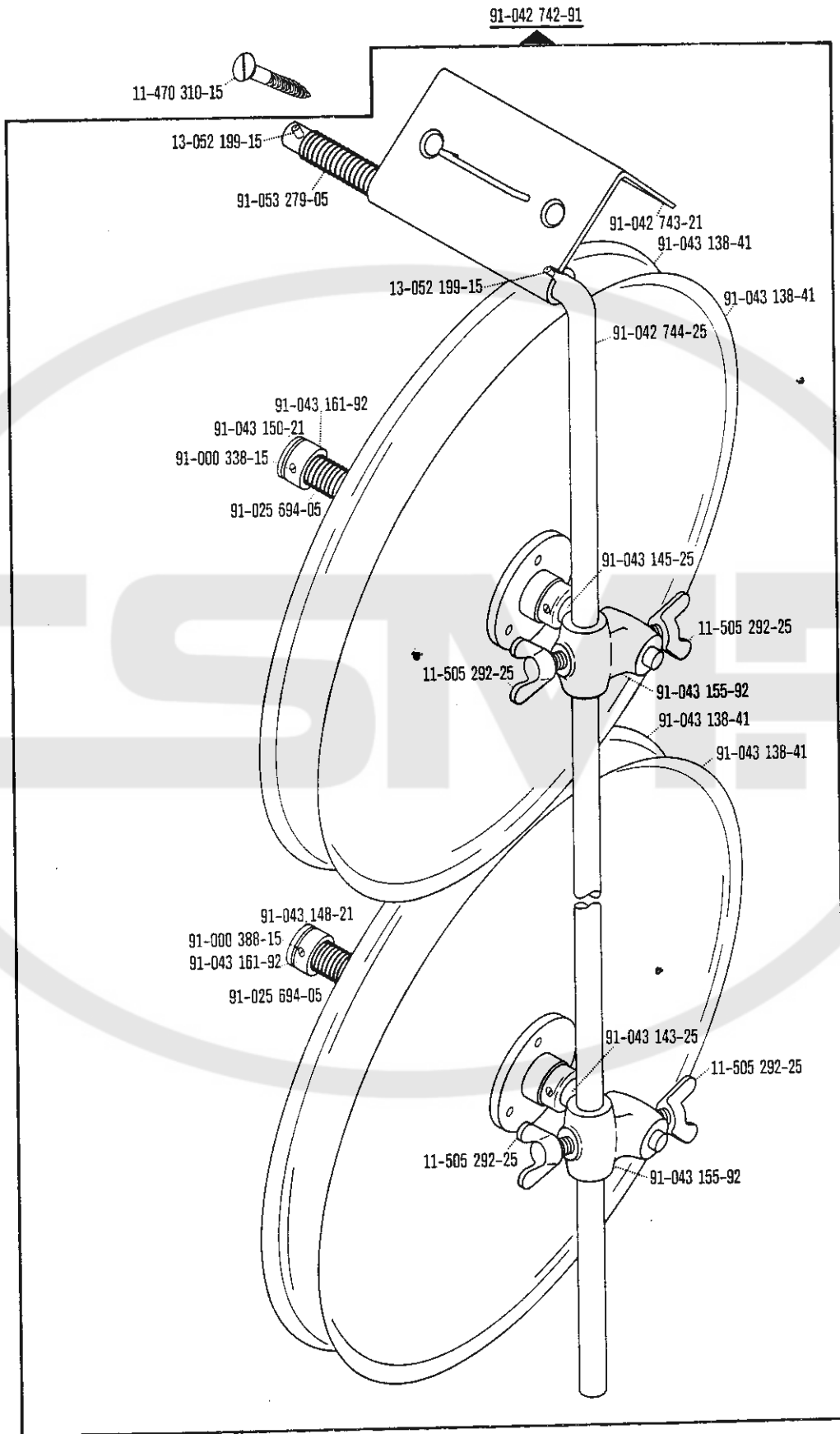

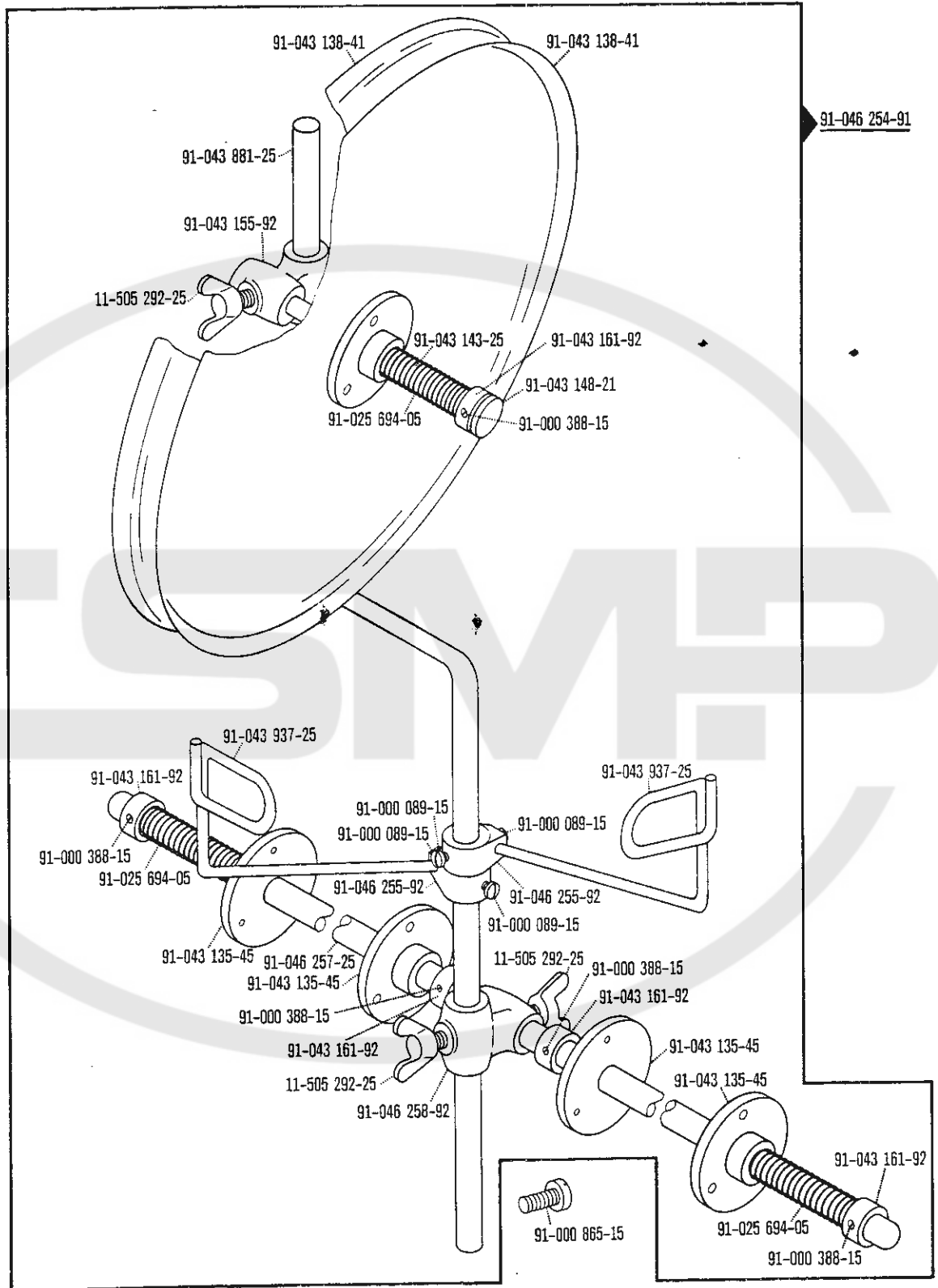



91-043 943-91

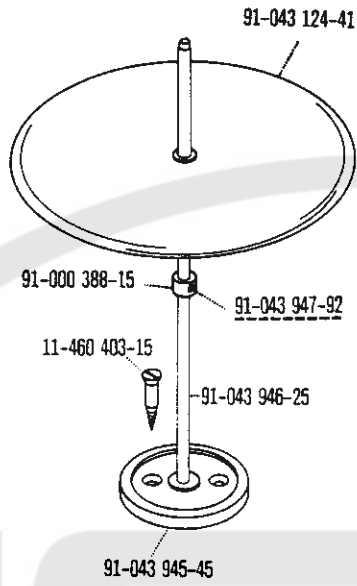

91-050 924-15

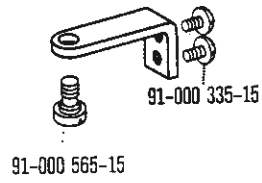

91-056 031-15



99-053 768-91

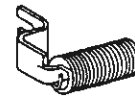

91-108 594-05

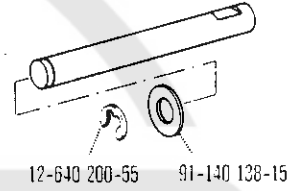

91-010 702-91

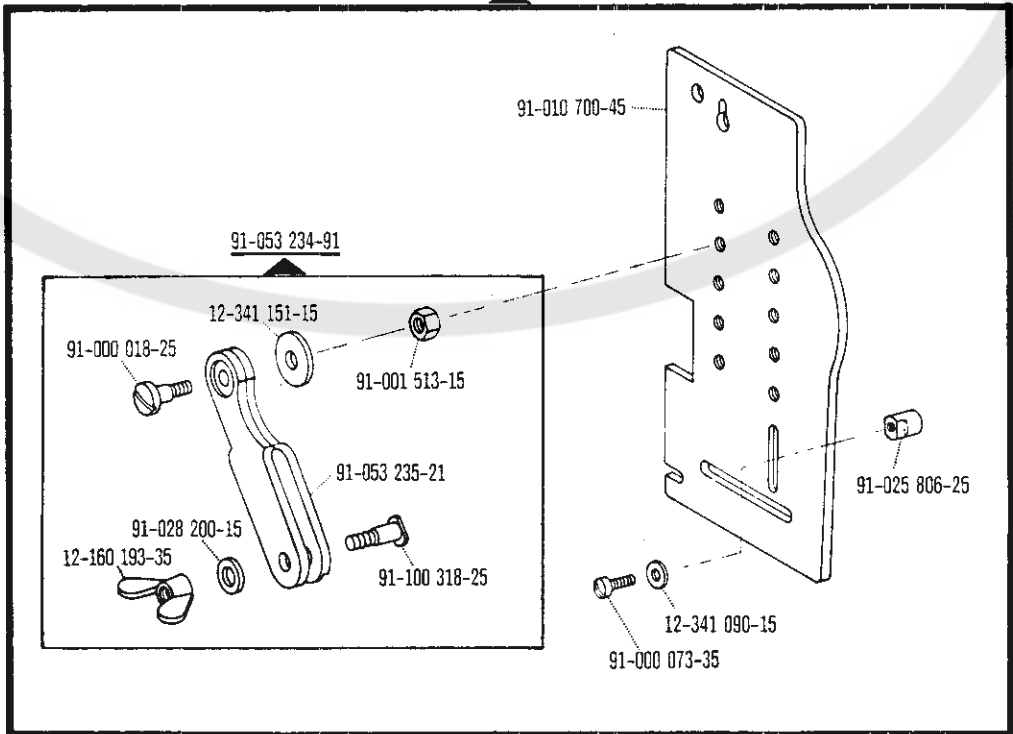

91-108 604-91

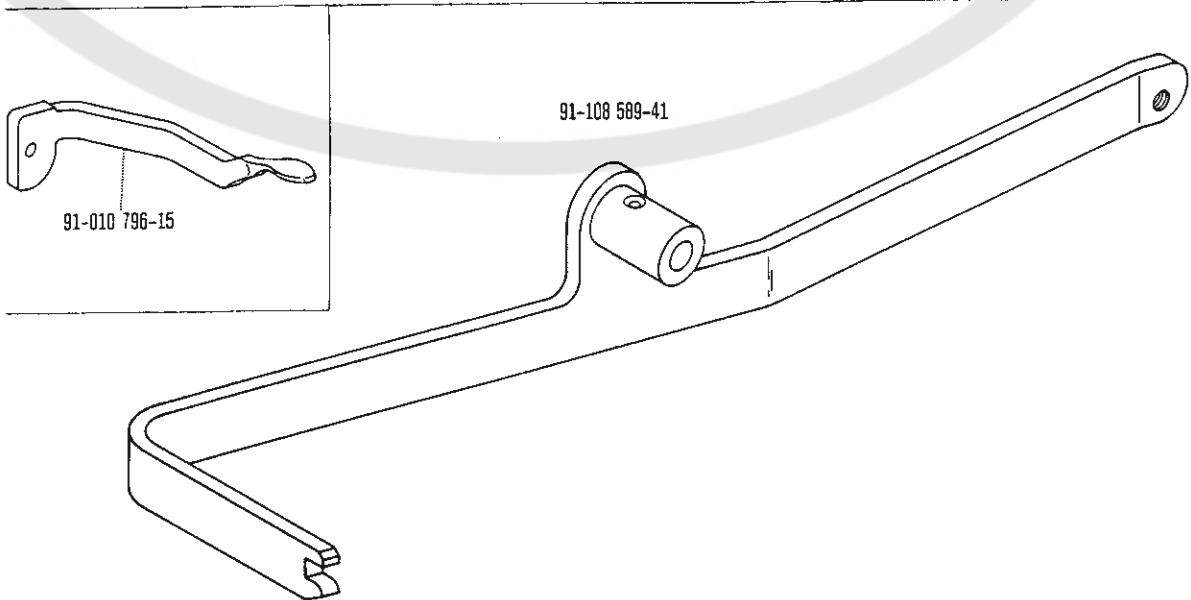
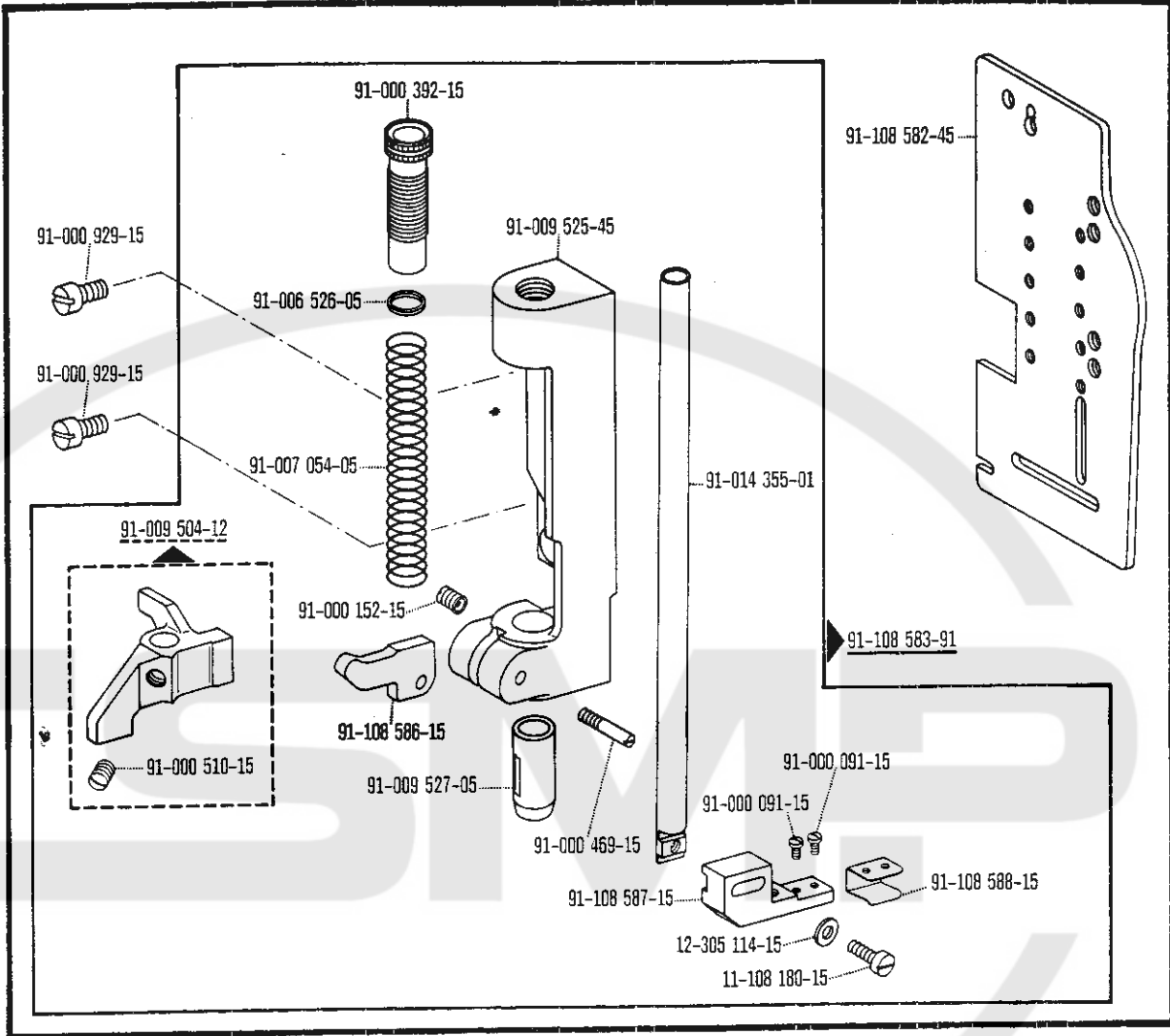

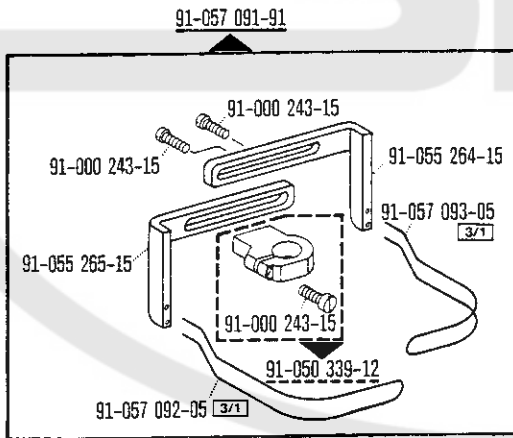
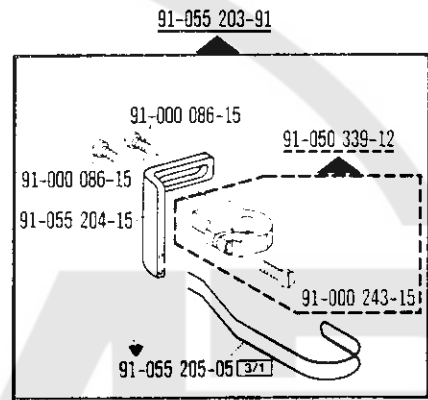
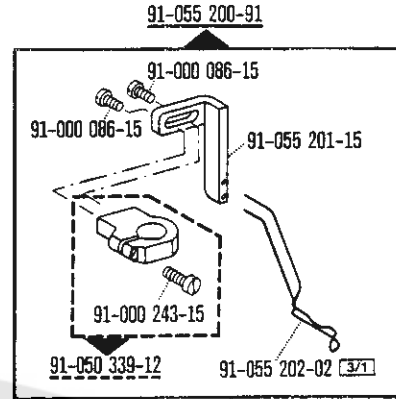
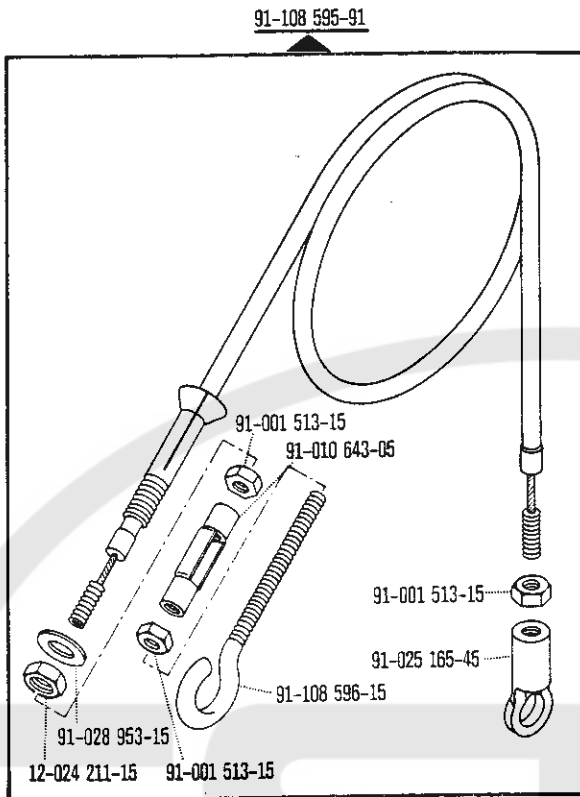

Pfaff, D 6750 Kaiserslautern, Postfach 3020/3040, Telex: 045 753